

Lubrication solutions for electromobility



BECHEM
LUBRICATION
TECHNOLOGY



Lubrication solutions for electromobility

Vehicles with electric drives are much more than a means of transportation with a novel drive concept.

Pure battery electric vehicles (BEV) call for major changes to design elements that constitute a new vehicle type with its own geometry. This is clearly seen in the vehicle architecture based on a skateboard platform with a shortened front, frequently additional cargo space, a large interior and a long wheel base. The lower center of gravity and the long wheel base enable both graceful cruising and sporty responsiveness in every vehicle class – not to forget the low noise level typical of electric vehicles. The demanding design requirements have even given rise to many advanced material developments.

The cockpit touchscreens are growing ever larger as well. The significantly smaller steering wheels in some cars presage the arrival of autonomous driving, which automotive engineers see coming our way in the not-too-distant future. The automobile industry is in a period of upheaval. In addition to its influence on a variety of other industries, electromobility has created entirely new market segments in the

two-wheeled sector with pedelecs, e-bikes and electric scooters, which will also have a great impact on transportation.

This transformation is driving declining demand for certain classic lubricants.* Along with elimination of the oil-lubricated combustion engine, the electric axle operates with a mini oil circuit that lubricates far fewer running elements in oil than does a combustion engine. The drive unit generally operates with a fixed reduction gear that requires very little maintenance. New tribological challenges also arise from new components and materials, generating a corresponding demand for lubricants.

BECHEM offers the automotive industry a global partnership for lubricant development and production. With its laboratories and state-of-the-art chemical and physical testing and analysis systems, BECHEM is ready to develop the right lubrication solutions for applications the world over.

*This brochure does not address hybrid technology nor the fluids used for battery temperature control, such as glycol/water mixtures.

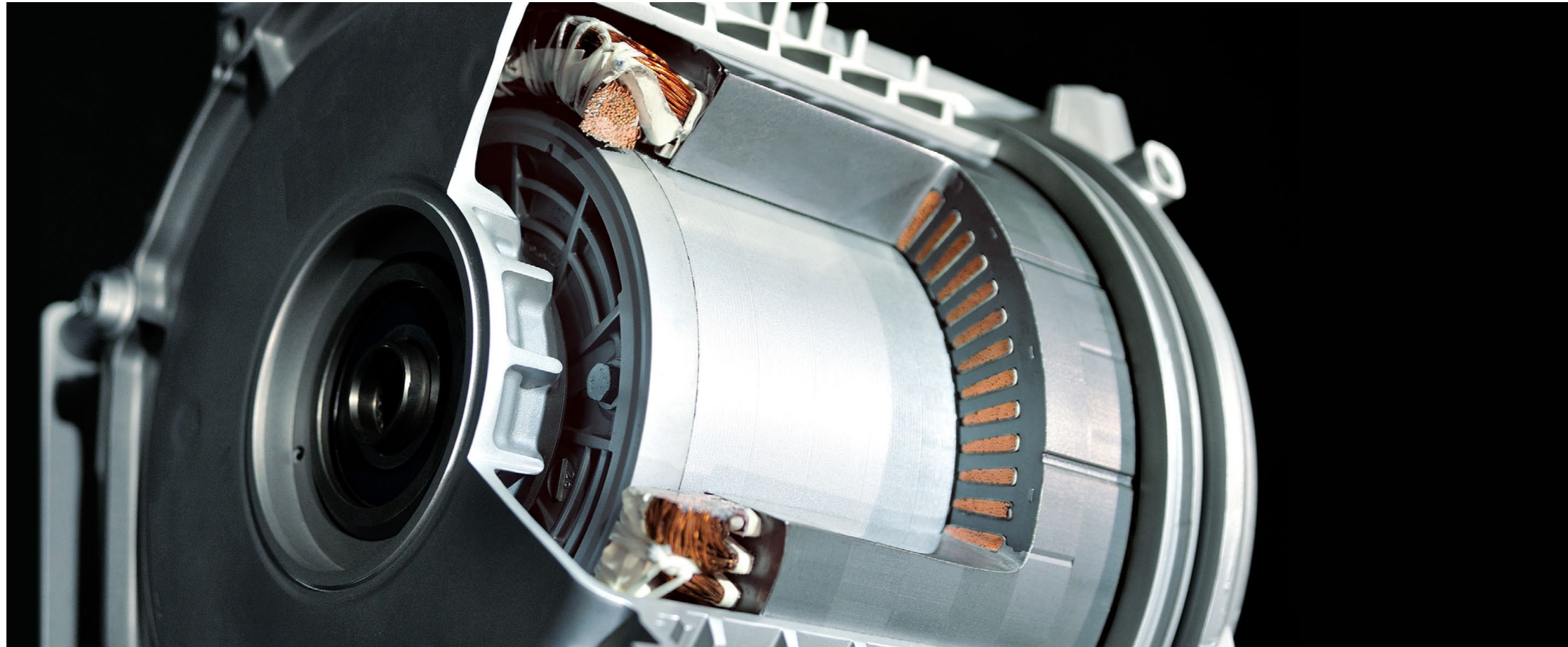

Copper wire windings flawlessly produced with BECHEM lubricants in the electromagnetic coils

Core technology

Alongside the battery, it is the electric motor and the power electronics that form the technological core of an electric car. High-quality copper wire windings are needed to create the electromagnetic coil of the stators and for the rotors of separately excited synchronous motors. BECHEM offers a high-performance and proven range of products for everything from production of the continuous cast rods to the drawing, annealing and further processing steps.

The outstanding drawing lubricants of the **BECHEM Unopol series** are used by globally leading brands for the production of diverse wire geometries. BECHEM always has its finger on the pulse of technological advancements, adapting to ever-changing and increasingly complex machine technology. As a member of the NF Wire Forum consortium, BECHEM is in close contact and communication with important tool makers and machine builders.

» Technological leadership through partnerships and intensive communication. «

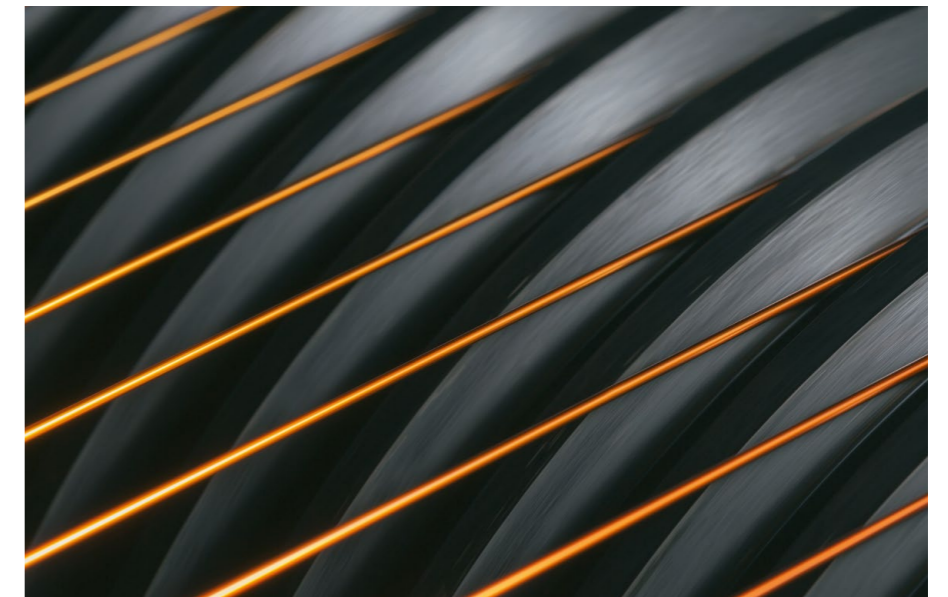

BECHEM is a member of the NF Wire Forum, together with Aurubis, Balloffet, the Niehoff Group and the German Copper Institute

A fine edge

High-precision fine cutting and stamping processes with long tool lifespans play an important role in the production of many automotive components. From an expert's perspective, even the smallest deviations from the defined geometries at the edges of the electrical steel used in the production of rotors and stators can result in unwelcome decreases in performance. Installing stators and rotors machined with worn tools in the motor cores leads to a reduced magnetization level and consequently lower motor efficiency. Ask about BECHEM solutions for complicated and challenging fine blanking operations.

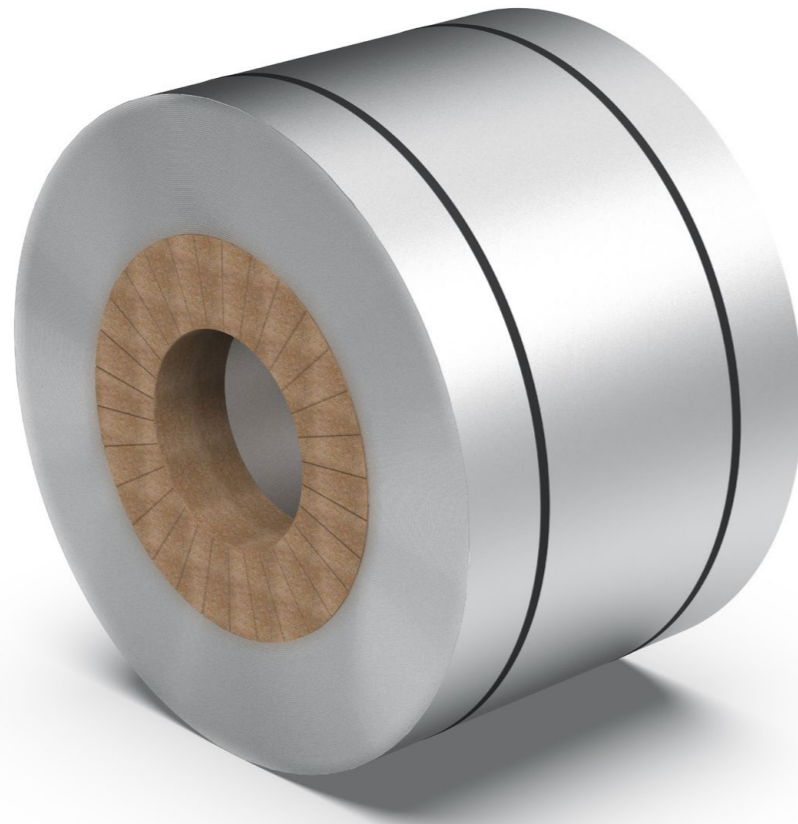

BECHEM forming lubricants support resource-efficient near net shape technologies such as fine blanking to reduce process times and eliminate manufacturing steps

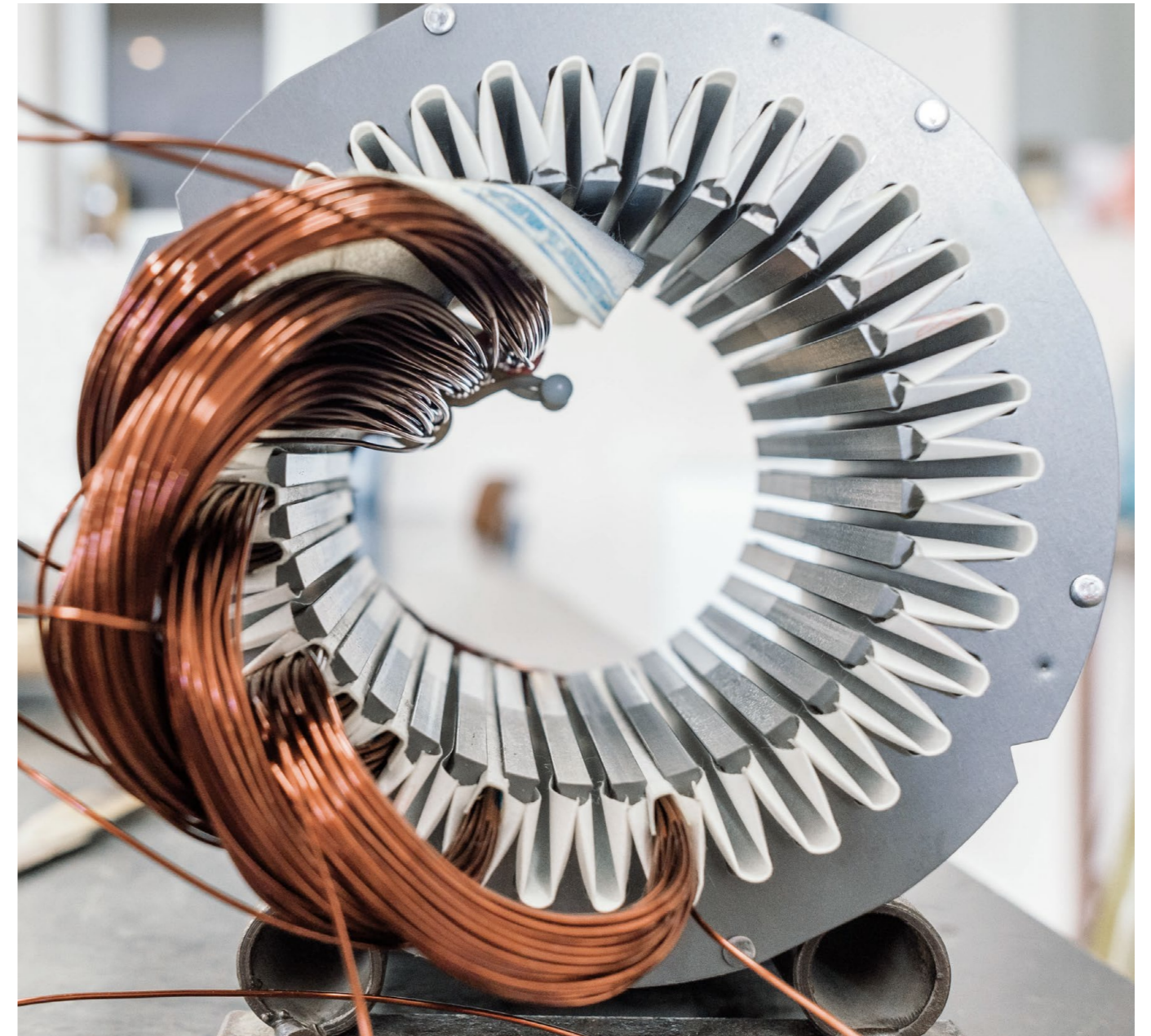

High-precision manufacturing with sharp punches is an essential part of electrical steel machining when it comes to building highly efficient electric motors



Whisper-quiet

Some lubricated switches are disappearing from the dashboard as these functions are moved to touchscreens. This decrease in the number of lubrication points is contrasted by a growing number of servomotors, actuators and fans that call for extremely silent lifetime lubrication of their spindle drives, roller bearings and plain bearings since the masking effect of the combustion engine is no longer present.

BECHEM supplies a wide product range for diverse applications, such as special, low-noise lubricating greases and products for complex challenges with respect to material compatibility and operating temperature.

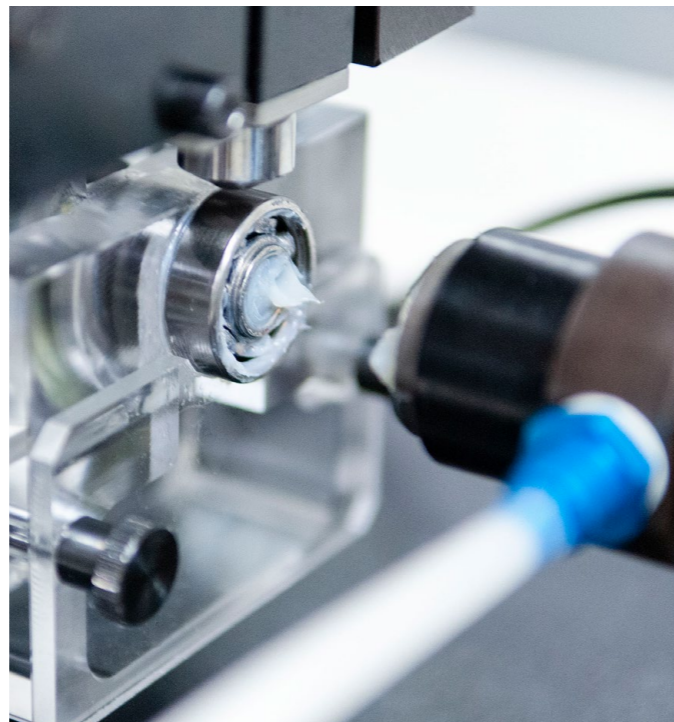

Measuring the noise class of lubricating grease according to the SKF BeQuiet standard

BECHEM offers new low-noise, high-speed lubricating greases of noise class GN4 with a base oil viscosity of 100 mm²/s at 40 °C, which also perform impressively in applications at lower speeds to cover a uniquely wide spectrum of operating conditions.

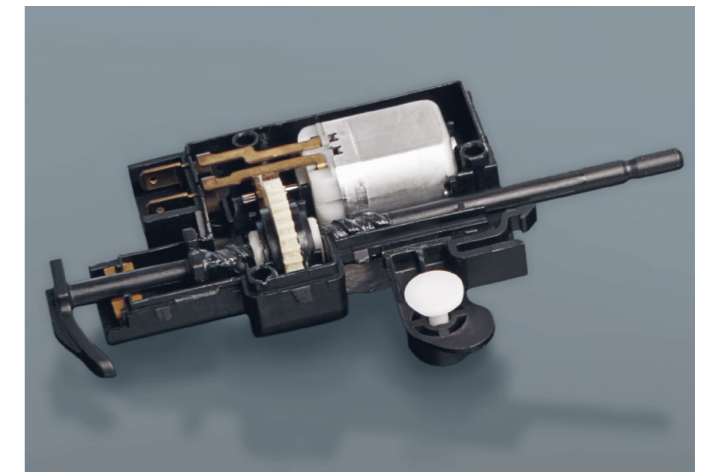

BECHEM lubricating greases with minimal and defined oil separation for applications in or near electromechanical components

A quiet ride

Not only the elimination of combustion engine noises but also a variety of measures to reduce wind and rolling noises produce a driving experience with an extremely low noise profile. This is made possible by acoustic films in windshields, body insulation, the replacement of exterior mirrors with camera systems and even foam elements added to tires. The result: Stick-slip creaking noises, such as from the bellows movement while steering, or smacking noises from the twisting of the car body are perceived more clearly by the driver and passengers than before. Typical functional noises of switches and adjusting mechanisms in the seat modules can also be irritatingly loud unless they harmonize with the quality profile of the vehicle and its acoustic design.

Gentle, quiet gliding and stopping calls for high-quality special lubricants with outstanding damping properties to suppress annoying noises for the lifetime of the car. BECHEM has developed an extensive range of lubricants and anti-friction coatings that contribute to significant improvements in driving comfort while also offering excellent material compatibility.

Special lubricants enable specifically tuned vibration damping, friction value optimization and controlled, reproducible movements. This supports custom haptic and acoustic properties for kinematic components.

BECHEM is the first lubricant manufacturer to introduce series production of anti-friction coatings with micro-encapsulation.

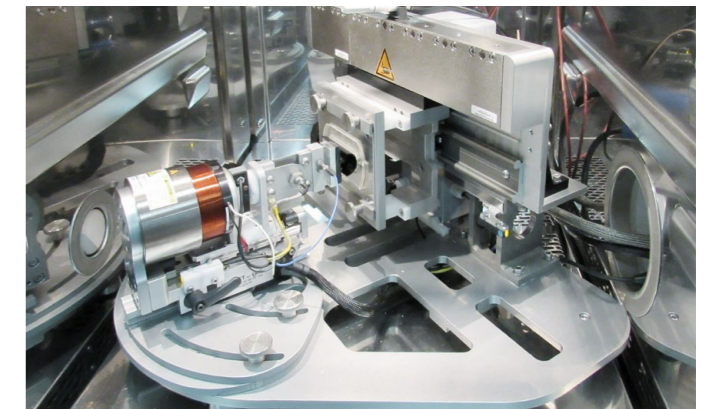
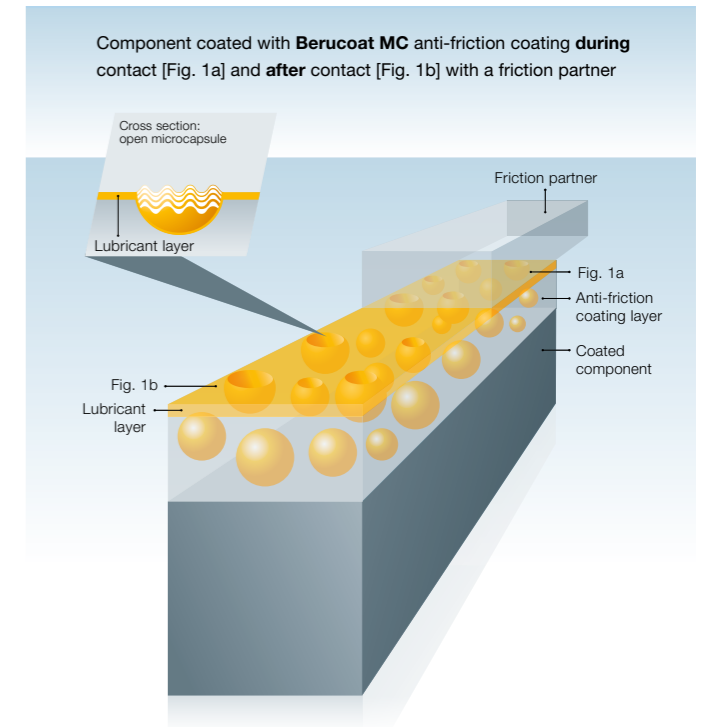

Parts on a stick-slip test bench for determining noise potential. Temperature and humidity effects can also be simulated in combination with a climatic chamber

Proven performance in e-mobility and in classic premium segment vehicles: Special lubricating greases, fluids and dispersions of the Berulub ND and Berusoft product series

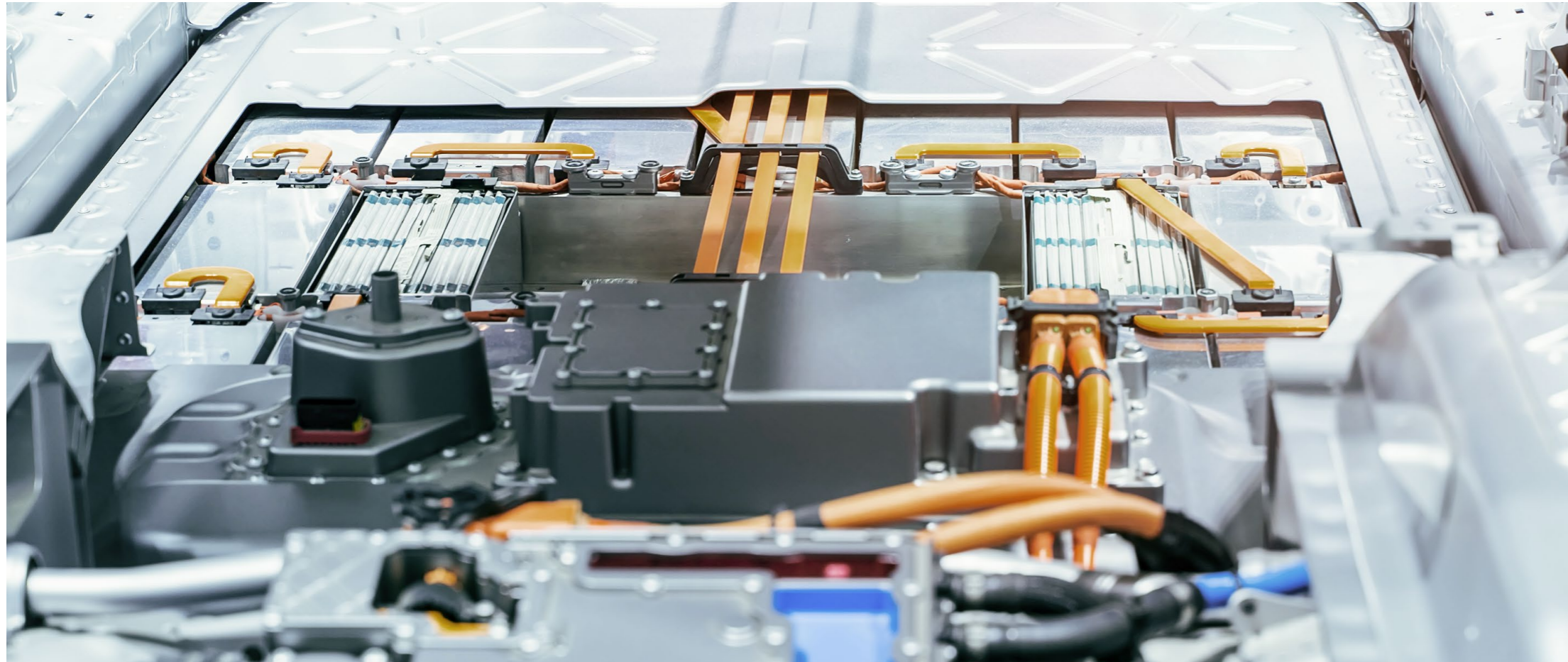

The heavy batteries are secured by a large number of complex connection elements

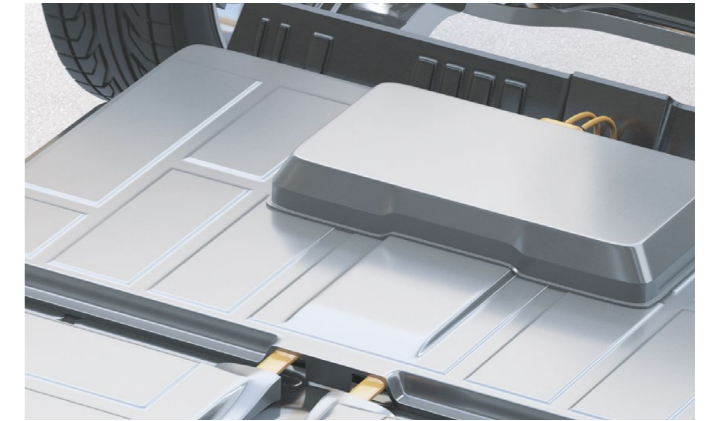

Improved heat dissipation thanks to silicone-free thermal conductive pastes in the battery trays along with vibration reduction



BECHEM products also play a valuable role in the production of crash frames and other frame components, such as for connection and support elements that require demanding drilling, turning, milling and grinding processes as well as forming

Firm connections

In addition to classic weld joints, electric vehicles also feature many – sometimes highly complex – applications for joining elements: Crash frame, battery tray, top cover, underbody protection for the battery and the power electronics housing.

To increase the share of environmentally friendly production processes and produce parts with fewer pollutants, optimized resource efficiency is an important topic for the creation of specially manufactured screws, bolts and sleeves. BECHEM supplies an extensive range of high-performance

forming lubricants for the multistage wire forming process (cold extrusion). BECHEM has done pioneering work in this application area with the process of zinc-phosphate-free wire coating by demonstrating improved environmental-friendliness and energy efficiency.

For the efficient and sustainable processing of the various frame profiles and other support elements, BECHEM cooling lubricants for turning, drilling and milling as well as sheet forming media are used by a leading producer of electric vehicles.

» High-performance forming lubricants for cold extrusion. «

At the turning point

Tried and tested BECHEM high-performance lubricating greases perform reliably in classic automotive components. In manufacturing as well, advanced, state-of-the-art processing media are utilized for machining and forming, such as water-based lubricants and separating agents for the production of rotor shafts.

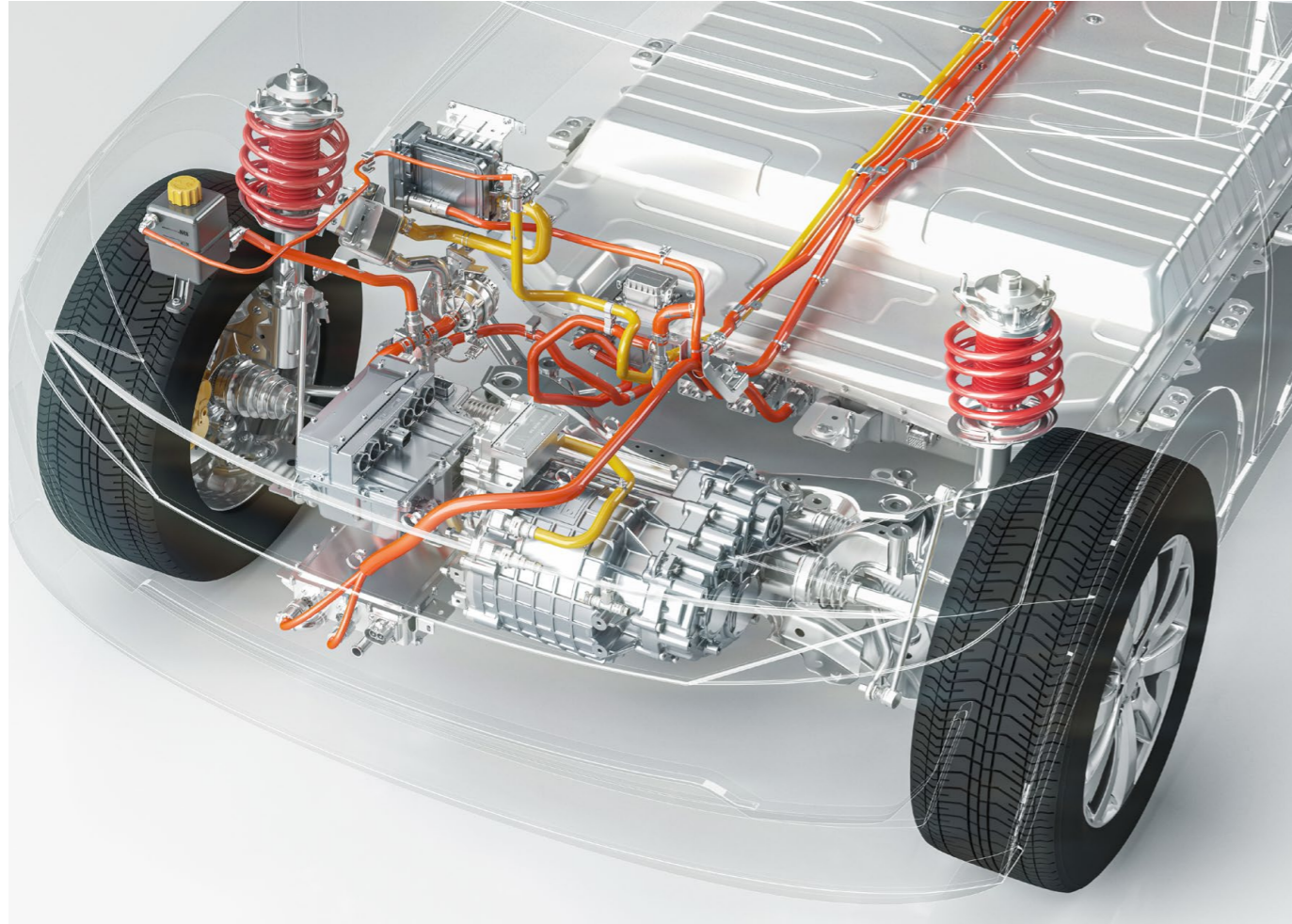

Speeds on the order of 20,000 rpm are standard in electric motors. Development efforts are striving for speeds as high as 50,000 rpm. The shaft that holds the rotor is supported in two high-performance ball bearings. In order for cardan shafts to continuously transmit the high torques to the wheels, they are assisted by a low-maintenance, oil-lubricated single-speed transmission. Alongside these applications, BECHEM offers high-performance solutions for many classic components of the vehicle chassis.

BECHEM also has answers on hand when it comes to questions of material compatibility between plastic and metal gears in other e-mobility applications, such as e-bikes and electric scooters.



Moderate temperature curve at high performance

Berutemp PE 2-10 HS delivers impressive performance figures at speeds exceeding 50,000 rpm in the FAG WS 22 spindle bearing test (hybrid bearing) and in the SKF BeQuiet test with the best possible noise class GN4.

● Bearing 1
 ● Average
 ● Bearing 2
 $n \times d_m = 2.25 \text{ Mio.}$
 $53,000 \text{ min}^{-1} \times 42.5 \text{ mm} = 2,250,000 \text{ mm/min.}$
 Temperature difference:
 Bearing temperature to room temperature

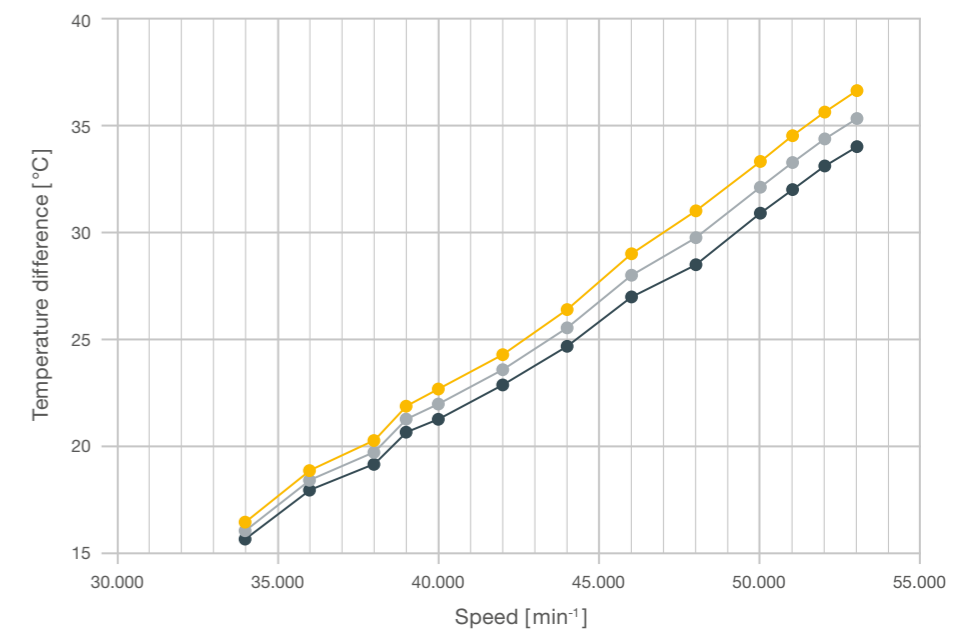

In close contact

During loading operations in cargo infrastructure and in vehicles, contact systems are subject to very wide temperature ranges as well as a high number of access cycles.

High mechanical insertion and releasing forces also produce additional wear.



Risk of wear from high mechanical insertion and releasing forces

BECHEM products for electrical contact lubrication meet the highest demands for lubrication, protection improved electrical conductivity. With their wide operating temperature range, they make a major contribution to the long lifespans and sophisticated functionality of advanced electrical contact systems. They are also compatible with most plastics and insulation materials. BECHEM works closely with the automotive industry to develop special solutions for OEMs as well as for the service, after-sales and accessory sectors.

In addition to classic lubricant products, other possibilities include special anti-friction coatings – potentially combined with lubricants.

Hydrophobic coatings can prevent contact with water, such as on covered door handles, locking systems or mechanical covers on charging connections, while also limiting the formation of ice layers thanks to pearling effects.



Door handles optimized for minimal wind resistance: Hydrophobic coatings can reduce the disruptive influence of water

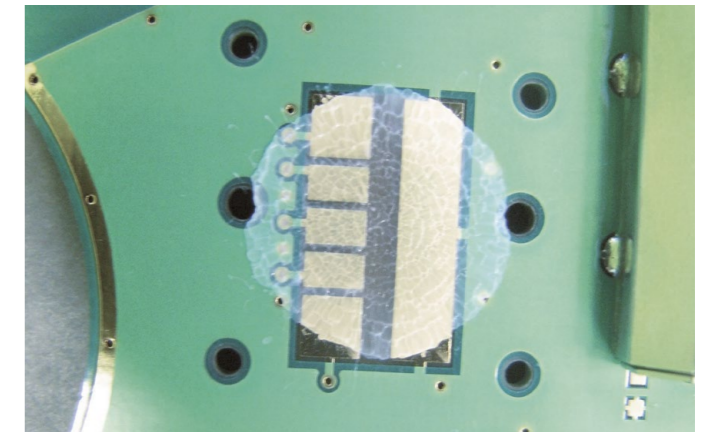

High-precision application on circuit boards with the right spray technology*

*Strategic partnerships with highly specialized technology providers allow BECHEM to offer effective solutions for highly complex issues.

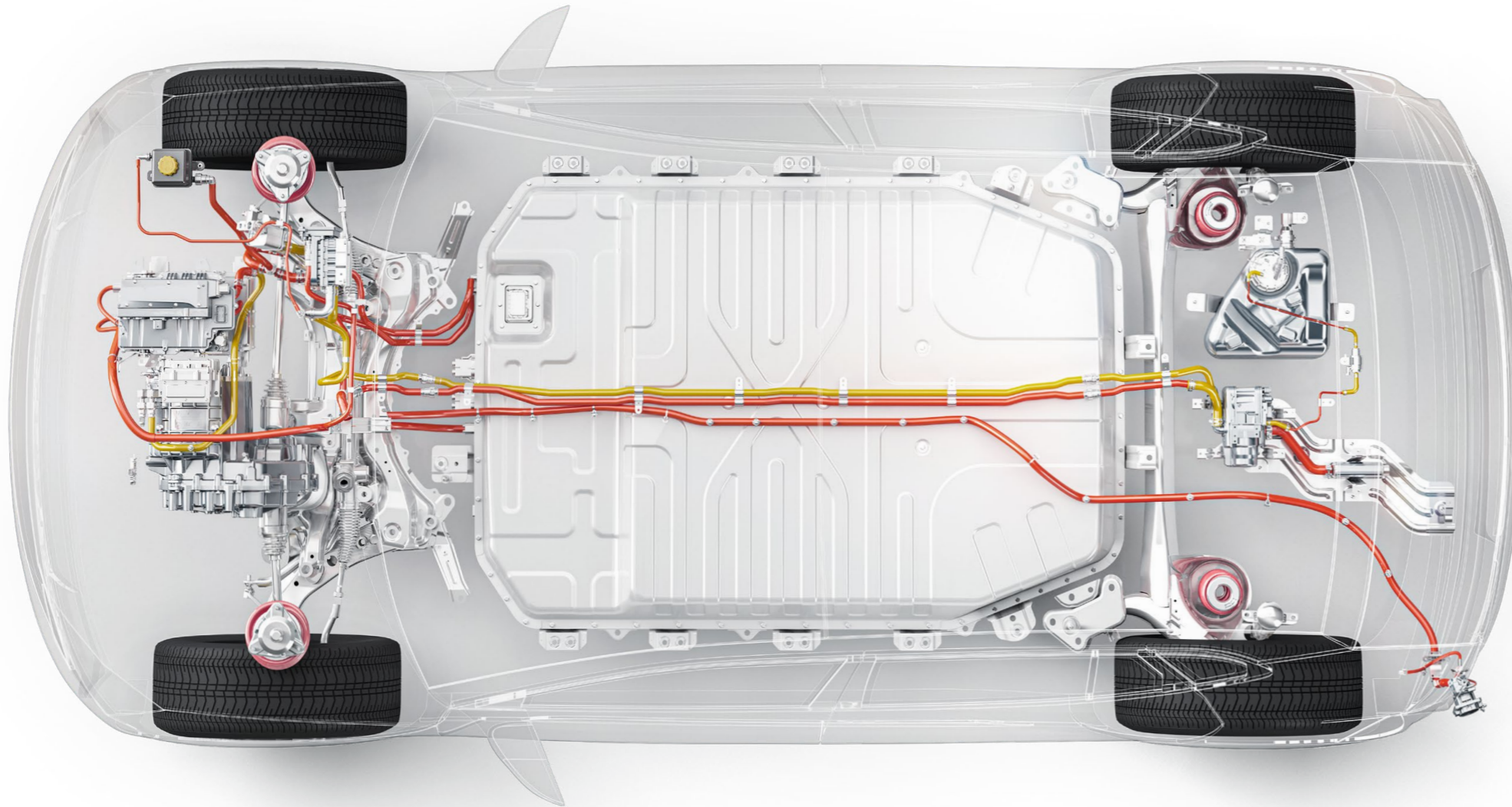

Wired for the future

The manufacturing of wiring for vehicle electrical systems is associated with tremendous challenges, such as the reliability of the wires and the use of new materials and alloys for both power transmission and signal transmission at very high data rates. Miniaturization of the electrical systems also poses its own design and assembly challenges. For the creation of complex wiring systems and vehicle electrical networks, BECHEM supplies the industry with high-quality drawing lubricants for diverse material alloys and reduced wire cross-sections.

For the assembly of such systems, BECHEM offers optimized sliding agents and assembly aids. With regard to future alternatives based on rigid components, BECHEM offers functional coatings that ensure lasting contact and corrosion protection while also minimizing noise.



Awarded

High-quality lubricants are indispensable products that are worth their investment. They have received prestigious awards – by making a decisive contribution to performance, energy efficiency and sustainability of products and processes.



Award for Berufluid – a joint project with Fraunhofer Institute IVV and IWF Braunschweig.

BECHEM wins award for tailored solutions in the premium vehicle sector.



BECHEM as an award-winner is one of the 20 most innovative companies in North Rhine-Westphalia.

BECHEM wins the award for innovative lifetime lubrication of various vehicle components.



BECHEM wins the NRW Efficiency Award for innovative and resource-efficient coating in cold massive forming.

Lubrication solutions for industry



CARL BECHEM GMBH

Weststr. 120 · 58089 Hagen · Germany · Phone +49 2331 935-0 · Fax +49 2331 935-1199 · bechem@bechem.de · www.bechem.com